

Airpower & Phonny

Hand dryers and hair dryers

O.ERRE
tecnologia dell'aria

UTILITY
R A N G E

AIRPOWER

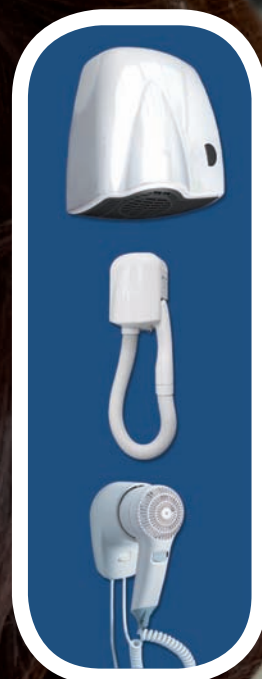
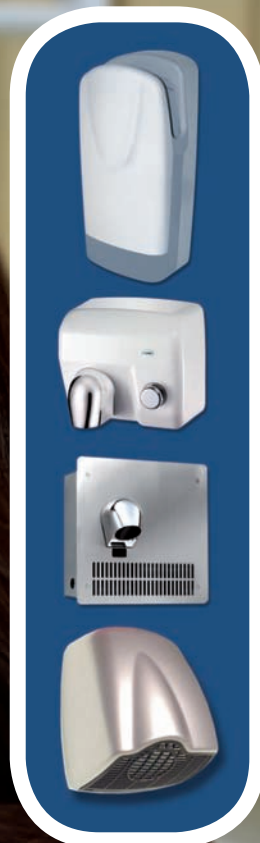

PHONNY

Airpower

HAND DRYERS



CYCLONE

Dry hands before you have time to say "dried hands".



AV BP and BF

More power at less cost.



ABS BP and BF

Silence: design matters

Phonny

HAIR DRYERS



BP and BF

You'll want to run your hands through your hair.



TUBO

Reduced dimensions, bigger performances.



FILO

The gun is classic... the design innovative

AIRPOWER CYCLONE

HAND DRYERS



Dry hands before you have time to say “dried hands”.

AIRPOWER CYCLONE: revolutionary anti-vandal hand dryer suitable for high traffic facilities.

- New hand dryer with compressed-air blade
- Drying time: 15 seconds
- Model with Hepa air filter anti bacteria and dust for the maximum hygiene
- Colours: white, satin aluminium, chrome
- Starts automatically when you put your hands into the drying area
- Automatic shut-off system after 18 seconds
- High speed universal induction motor with inverter (32.000 r/min.)
- Suitable for high traffic facilities
- In accordance with all the international norms



All the efficiency of a powerful compressed-air blade.



Easy removing of recovery box.



New technology

CE

DIMENSIONS CYCLONE

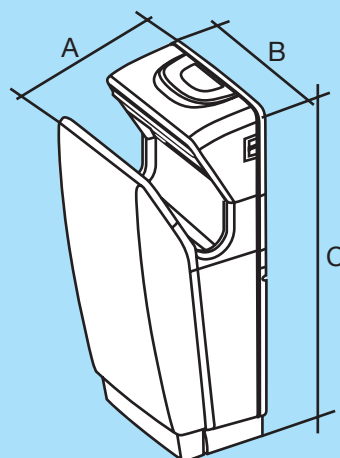

A	250 mm
B	292 mm
C	650 mm

TECHNICAL DATA

Type	Volt (50/60 Hz)	Max flow rate (m³/h)	Air speed (km/h)	Motor (W)	RPM	PI protection	Insulation	Weight (kg)	Warranty
by sensor	220 / 240	345	300	1750	32.000	IP33	Class II	9,5	5 years

ANTI-VANDAL

AIRPOWER ANTI-VANDAL

PUSH BUTTON OR INFRARED SENSOR OPERATING

HAND DRYERS



More power at less cost.

The most versatile and “smart” anti-vandal hand dryer.

- Metal anti-vandal hand dryers 2400 W
- Material: steel
- Colours: Porcelain white, satin steel, chrome
- Functioning by push button or infrared sensor
- ES Energy Saving model (1500 W)
- Smart recognition system between actual activation’s requests and random passing
- Automatic disconnection system after 60 seconds
- Adjustable timer between 25” and 60” (Push button)
- Double thermostat (on both engine and heating element)
- Top reliability, power and safe guarantees



Air nozzle can be turned 360°!



Anti-vandal



DIMENSIONS ANTI-VANDAL

A	320 mm
B	180 mm
C	300 mm
D	340 mm

A	284 mm
B	248 mm
C	202 mm

TECHNICAL DATA

Type	Volt (50/60 Hz)	Max flow rate (m³/h)	Air speed (km/h)	Motor (W)	Heating COIL (W)	RPM	IP protection	Insulation	Weight (kg)	Warranty
by push button	220 / 240	270	101	200	2200 / 1500 (*)	5500	IPX1	Class I	6,2	5 years
by sensor	220 / 240	270	101	200	2200 / 1500 (*)	5500	IPX1	Class I	6,1	5 years
built-in	220 / 240	270	101	200	2200 / 1500 (*)	5500	IPX1	Class I	11,5	5 years

(*) ES Energy Saving version

AIRPOWER IN ABS

PUSH BUTTON OR INFRARED SENSOR OPERATING

HAND DRYERS



Silence: design matters.

Hand dryer with an exclusive design that makes it adaptable to any kind of internal environment: discreet and...quiet.

- Functioning by push button or infrared sensor
- Quite operating and maximum efficiency
- Easy maintenance and cleaning thanks to the interchangeable elements
- Colours: white, satin aluminium, chrome
- Adjustable inducing distance
- Adjustable timer between 25" and 180" (Push button)
- Automatic disconnection system after 60 seconds (Sensor)



Its smooth design makes it adaptable to any environment!



Dried hands... in a breath!



Reduced noise level

CE

DIMENSIONS ABS

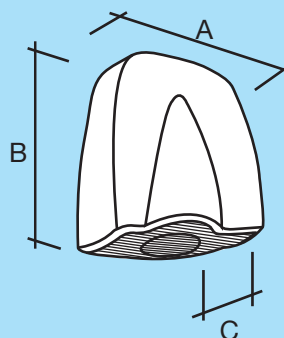

A	262 mm
B	305 mm
C	165 mm

TECHNICAL DATA

Type	Volt (50/60 Hz)	Max flow rate (m³/h)	Air speed (km/h)	Motor (W)	Heating COIL (W)	RPM	IP protection	Insulation	Weight (kg)	Warranty
by push button	220 / 240	234	75	65	1785	3000	IPX2	Class II	2,6	3 years
by sensor	220 / 240	234	75	65	1785	3000	IPX2	Class II	2,6	3 years

PHONNY BP and BF

PUSH BUTTON OR INFRARED SENSOR OPERATING

HAIR DRYERS



You'll want to run your hands through your hair.

Hygiene and freedom to act makes PHONNY BP and BF the ideal hair dryer suitable for high traffic or restricted facilities.

- Functioning by push button or infrared sensor
- Quiet operating and maximum efficiency
- Easy maintenance and cleaning thanks to the interchangeable elements
- Adjustable inducing distance
- Adjustable timer between 25" and 180" (Push button)
- Automatic disconnection system after 60 seconds (Sensor)



With your hands free, double practicality and care of yourself!



Reduced noise level



DIMENSIONS PHONNY

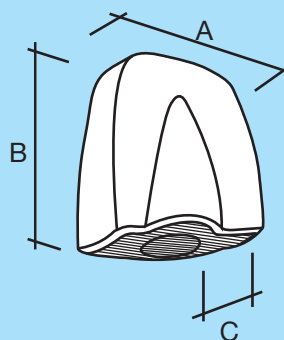

A	262 mm
B	305 mm
C	165 mm

TECHNICAL DATA

Type	Volt (50/60 Hz)	Max flow rate (m³/h)	Air speed (km/h)	Motor (W)	Heating COIL (W)	RPM	IP protection	Insulation	Weight (kg)	Warranty
by push button	220 / 240	234	75	65	1135	3000	IPX2	Class II	2,6	3 years
by sensor	220 / 240	234	75	65	1135	3000	IPX2	Class II	2,6	3 years

HAIR DRYERS



PHONNY FILO

The gun is classic...the design of “five stars”.

All the practicality of being at home when you are outside

- The less possible width
- Innovative design
- Two speeds
- ON-OFF bipolar switch for maintenance on base
- Push-release start button
- Wall mounted

DIMENSIONS FILO

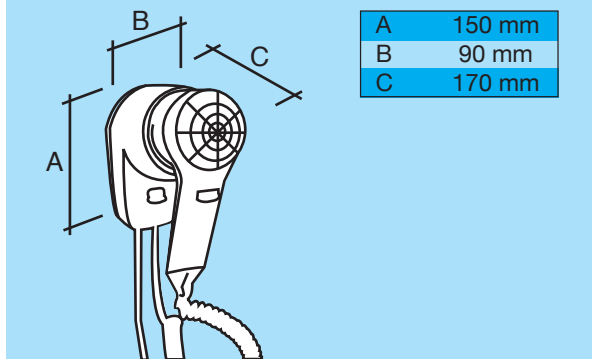

TECHNICAL DATA

Type	Volt (50/60 Hz)	Max flow rate (m³/h)	Air speed (km/h)	Motor (W)	RPM	IP protection	Insulation	Weight (kg)	Warranty
by gun	220 / 240	198	65	max 1200	4000	IP20	Class II	0,8	2 years

HAIR DRYERS



PHONNY TUBO

Reduced dimensions, big performances.

The smallest hair dryer with extensible hose

- Shaver socket 220V-110V.
- High performing AC motor
- Long life
- Highly energy saving
- Auto turn off system (after 5 minutes)
- Thermostatic protection
- Two speeds

DIMENSIONS TUBO

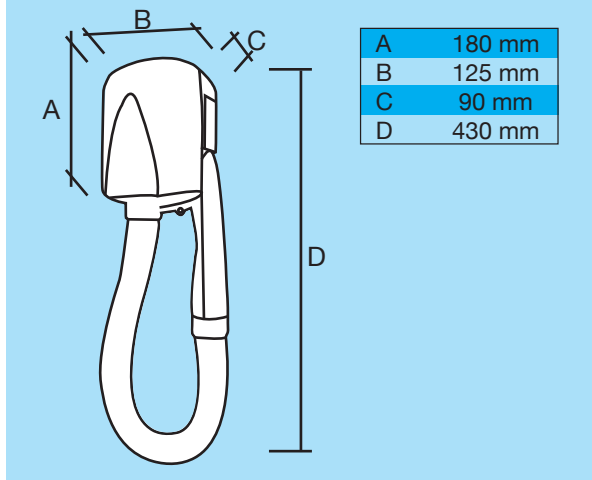

Shaver socket!

TECHNICAL DATA

Type	Volt (50/60 Hz)	Max flow rate (m³/h)	Air speed (km/h)	Motor (W)	RPM	IP protection	Insulation	Weight (kg)	Warranty
by hose	220 / 240	216	75	max 700	3400	IPX2	Class II	1,3	5years

Airpower: models



REF.	MODEL	TYPE	OPERATING	COLOUR
0020300	Airpower CYCLONE FB	air blade	sensor	White
0020310	Airpower CYCLONE FS	air blade	sensor	Satin aluminum
0020320	Airpower CYCLONE FL	air blade	sensor	Chrome
0020330	Airpower CYCLONE FB HEPA	air blade	sensor	White
0020340	Airpower CYCLONE FS HEPA	air blade	sensor	Satin aluminum
0020350	Airpower CYCLONE FL HEPA	air blade	sensor	Chrome

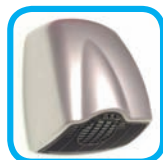

REF.	MODEL	TYPE	OPERATING	COLOUR
0020110	Airpower ABS PB	in ABS	push button	White
0020120	Airpower ABS FB	in ABS	sensor	White
0020130	Airpower ABS FS	in ABS	sensor	Satin aluminum
0020140	Airpower ABS FL	in ABS	sensor	Chrome



REF.	MODEL	TYPE	OPERATING	COLOUR
0020010	Airpower AV PB	anti-vandal	push button	Porcelain white
0020011	Airpower AV PB ES	anti-vandal	push button	Porcelain white
0020020	Airpower AV PS	anti-vandal	push button	Satin steel
0020021	Airpower AV PS ES	anti-vandal	push button	Satin steel
0020030	Airpower AV PL	anti-vandal	push button	Chrome
0020031	Airpower AV PL ES	anti-vandal	push button	Chrome
0020040	Airpower AV FB	anti-vandal	sensor	Porcelain white
0020041	Airpower AV FB ES	anti-vandal	sensor	Porcelain white
0020050	Airpower AV FS	anti-vandal	sensor	Satin steel
0020051	Airpower AV FS ES	anti-vandal	sensor	Satin steel
0020060	Airpower AV FL	anti-vandal	sensor	Chrome
0020061	Airpower AV FL ES	anti-vandal	sensor	Chrome
0020070	Airpower AV IN FS	built-in	sensor	Satin steel
0020071	Airpower AV IN FS ES	built-in	sensor	Satin steel

Phonny: models



REF.	MODEL	TYPE	OPERATING	COLOUR
0020210	Phonny BP	in ABS	push button	White
0020220	Phonny BF	in ABS	sensor	White



REF.	MODEL	TYPE	OPERATING	COLOUR
0020230	Phonny Tubo	in ABS	pulling out hose	White



REF.	MODEL	TYPE	OPERATING	COLOUR
0020240	Phonny Filo	in ABS	push button	White

O.ERRE
tecnologia dell'aria